

GH12130-SM

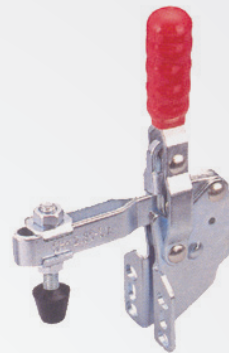
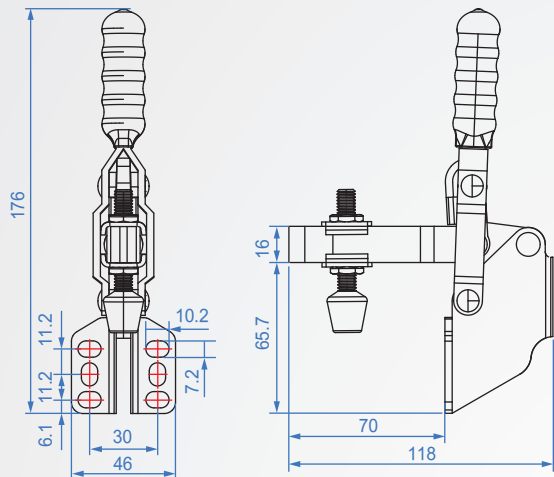
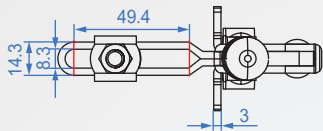

GH12130-SM

材質：SS400 表面處理：鍍鋅

單位：mm

Code No.	夾壓力(kg)	重量(g)	把手移動	夾頭移動	前端配件
GH12130-SM	227	395	56°	100°	NFC-56212