

GH22502-B

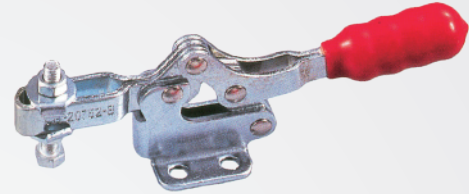
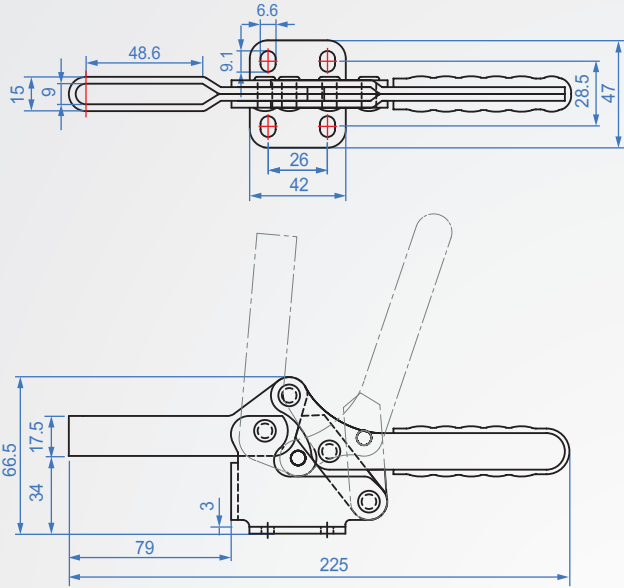

GH22502B

材質：SS400 表面處理：鍍鋅

單位：mm

Code No.	夾壓力(kg)	重量(g)	把手移動	夾頭移動	前端配件
GH22502-B	250	434	72°	90°	NSA-085012