

GH12002-B

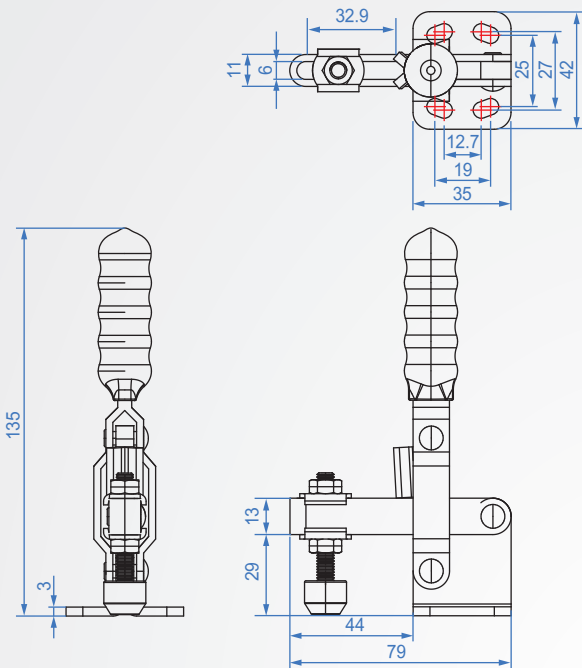

GH12002-B

Material : SS400 Finish : Zinc plated

unit : mm

Code No.	Clamping pressure (kg)	weight (g)	Handle movement	Chuck movement	Front end fitting
GH12002-B	150	230	70°	108°	NSA-064010

1N≒0.102kgf