

GH25383

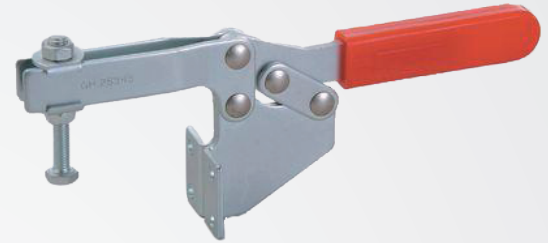
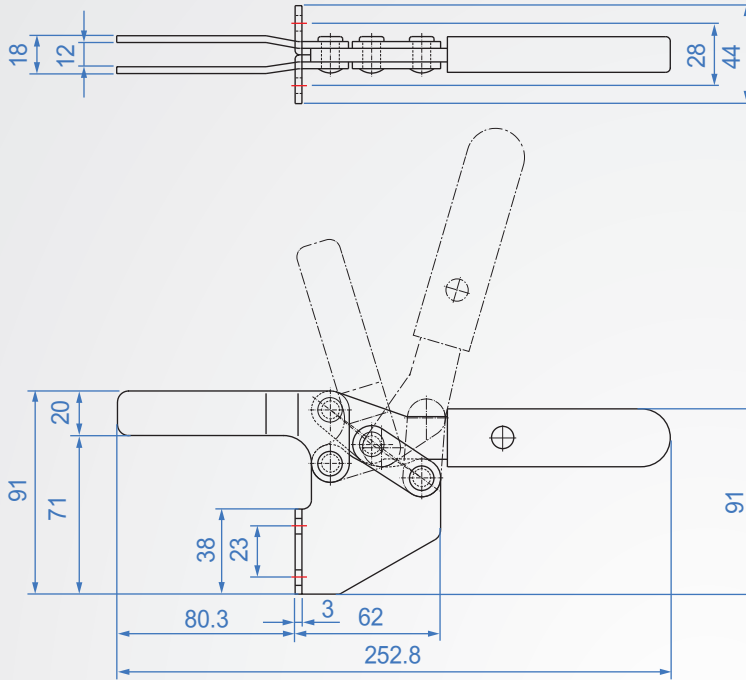

GH25383

Material : SS400 Finish : chromium plated

Unit : mm

Code No.	Clamping force(kg)	weight (g)	Hadle moving	Chuck moving	Front-end accessories
GH25383	280	497	87°	79°	NSA-086512