

## GH30513

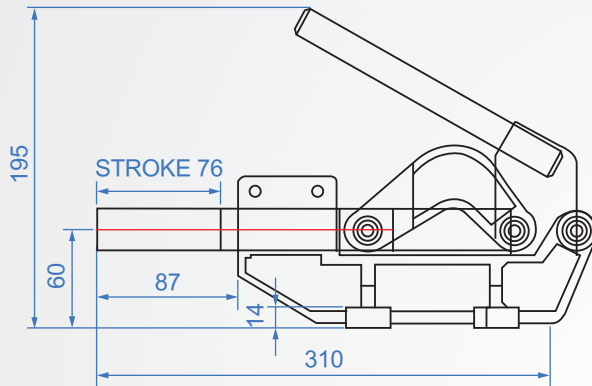
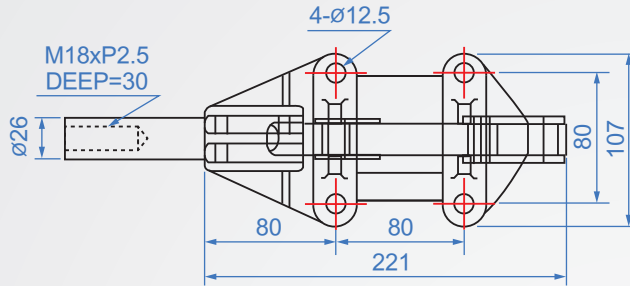

### GH30513

Material : SS400 Finish : Zinc plated

Unit : mm

Code No.	Clamping force(kg)	weight (g)	Hadle moving	Chuck moving	Front-end accessories
GH30513	1600	4060	180°	76	NSA-185025