

GH30513

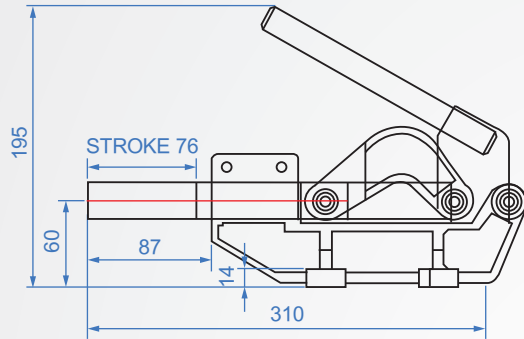
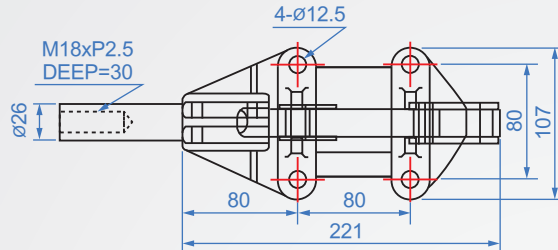

GH30513

材質：SS400 表面處理：鍍鋅

單位：mm

Code No.	夾壓力(kg)	重量(g)	把手移動	行程	前端配件
GH30513	1600	4060	180°	76	NSA-185025